



Basic Mechanical Specifications

Model	Suitable Machine Range	Axis Strokes (mm)			Driving Method	C Axis Posture (90°)		Linear Position Repeatability (mm)	Net Weight (kg)
		Traverse	Crosswise	Vertical		Maxi load kg	C Axis Posture Torque (Nm)		
KAW950S3	180--300T	1450	820	950	AC Servo Motor	7	25	+ - 0.1	240

Minimum Infrastructure Requirements

Working pressure (kgf\cm)	Consumption (NL\cycle)	Maximum Power (Kw)	Power (AC) Single Phase
5 -- 7	1.2	1.9	220 V, 50/60 HZ

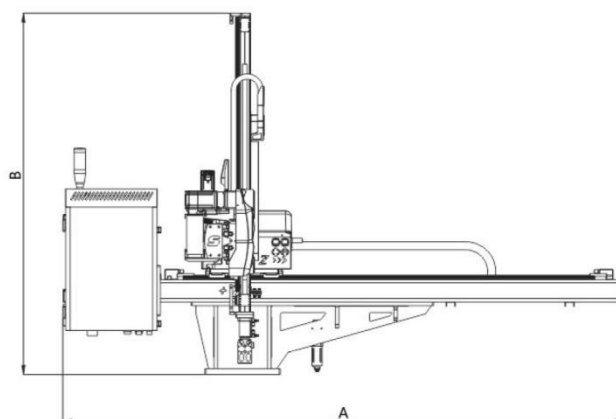
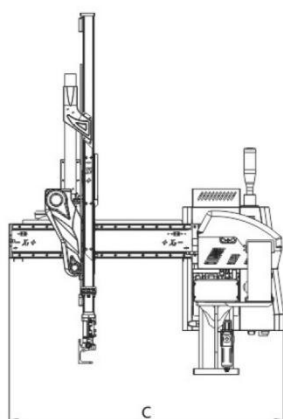

External Size

Model	A	B	C
KAW950S3	2010	1485	1700

General

1	Vacuum line	19	Crosswise J(Pass) Motion
2	Blow line	20	Defective Product Separation
3	Sprue Gripper line	21	Extra Mold Safety Sensor (Optional)
4	Telescopic Vertical Axis	22	Pause during Operation
5	Eco Model (Automatic Energy Saving Cycle Feature)	23	Stop and start
6	Product pickup from fixed and moving platens	24	IMM Door Open Permission during Pause
7	Conveyor Control	25	C Axis Rotation Control
8	Conveyor Control	26	90° Soft Stop
9	Mold Operation Function control	27	Connection Adapter Between Robot and Injection Machine
10	Selection of Operator / Non-operator Working Direction	28	English Software & Multi-language Support
11	Product Sorting and stacking	29	Maximum Payload Adjustment
12	Product sorting in matrix form	30	Operation Record Feature
13	Soft Sorting / Separation	31	Alarm Record Feature
14	Vacuum level Adjustment on the control Panel	32	USB Memory Connection
15	Multiple Language support on the control Panel	33	Memory OF up to 99 Molds
16	Product Extraction from core in the Mold	34	Ejector Control
17	Sprue Separation	35	Euromap 12/67 Robot Interface
18	Products Separation	36	Overload Protection



KEFAN Metal parts fabrication plant workshop & Airconditional Assembly workshop.

Website: www.kefanrobot.com. Tel: 0086-13857893619 / Email: info@kefanrobot.com